

Quick Setup Guide/Guía de ajuste rápido

DAV-TZ630

For details, refer to the Operating Instructions.
Para obtener más información, consulte el Manual de instrucciones.

1 Connecting the speakers/Conexión de los altavoces

First, assemble the speakers (refer to the Speaker Installation Guide), and then connect the speaker cords to match the color of the SPEAKERS jacks of the unit.

Primero, coloque los altavoces (consulte la Guía de instalación de los altavoces) y, a continuación, conecte los cables de altavoz de modo que coincidan con el color de las tomas SPEAKERS de la unidad.

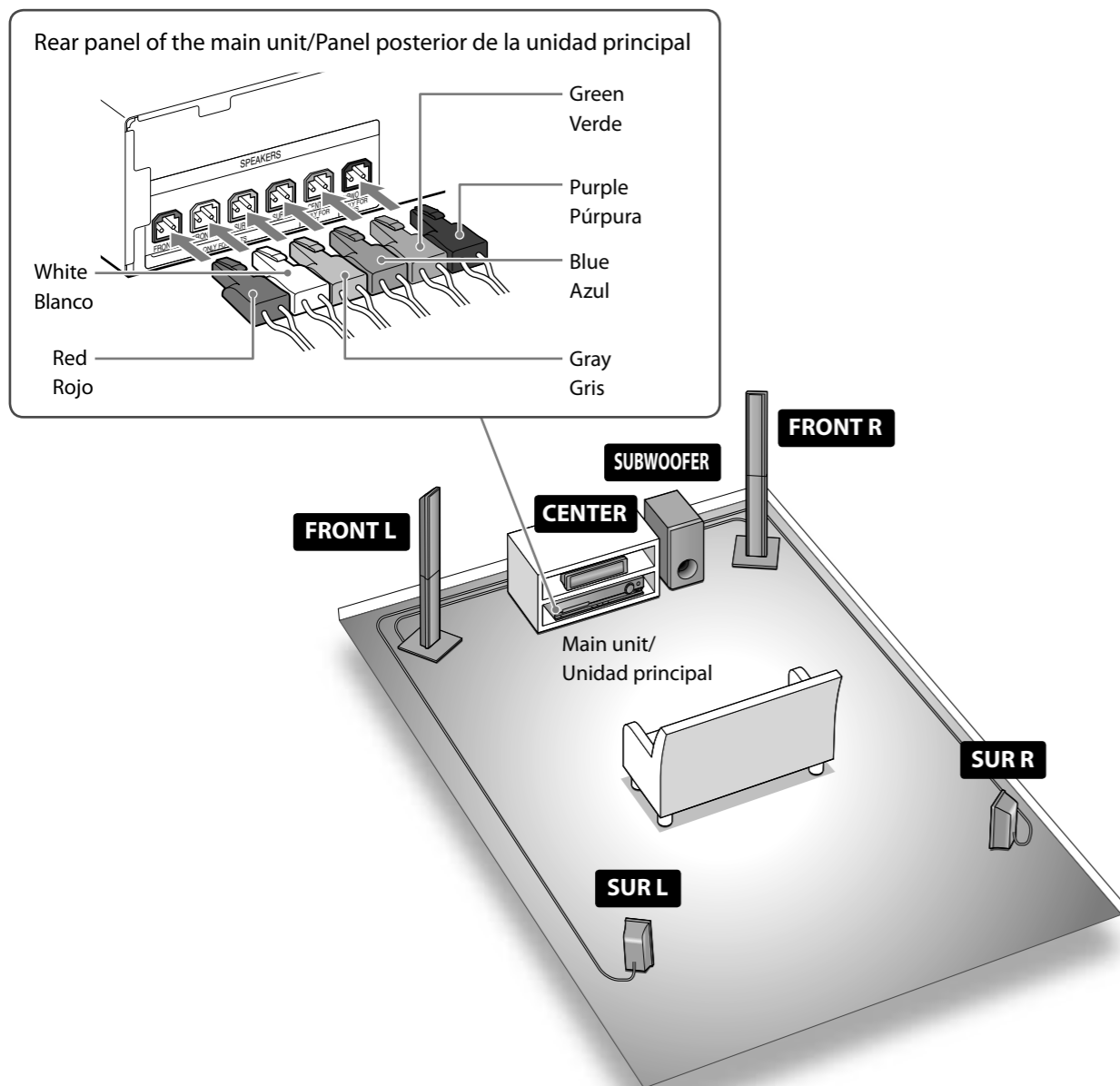

To connect speaker cords to the speaker/
Para conectar los cables de altavoz al altavoz

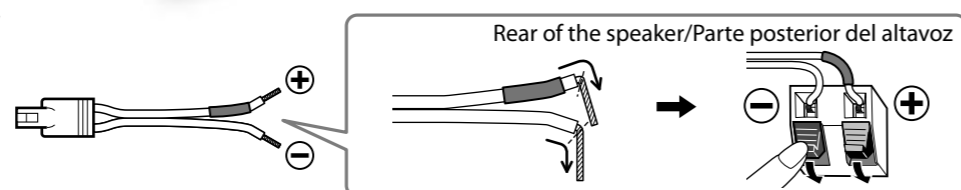

2 Connecting your TV/Conexión del televisor

Depending on the jacks on your TV, select one of the connection methods.
En función de las tomas del televisor, seleccione uno de los métodos de conexión.

Method 1: SCART (EURO AV) cable* connection Método 1: Conexión del cable SCART (EURO AV)*

This is the basic connection and sends both video and audio signals.
Esta es la conexión básica, que permite enviar señales de vídeo y audio.

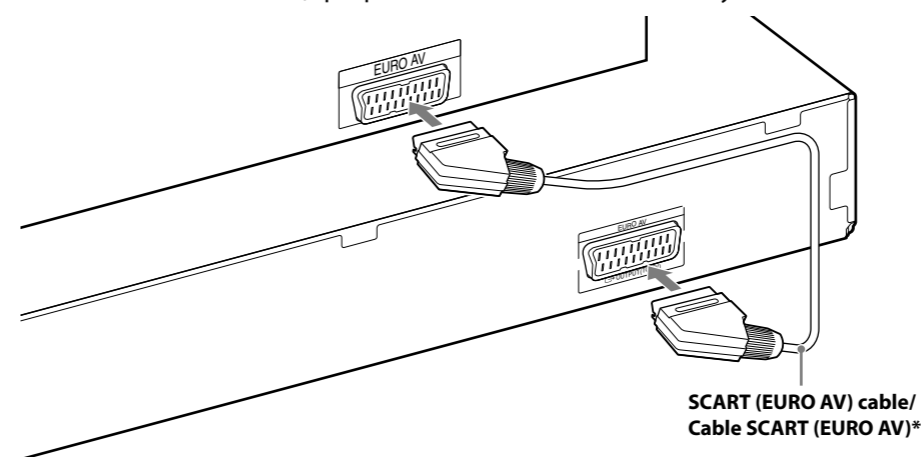

*Not supplied/No suministrado

Method 2: HDMI cable* and SCART (EURO AV) cable* connection Método 2: Conexión del cable SCART (EURO AV)* y el cable HDMI*

Picture quality will be improved compared to Method 1. To listen to TV stereo sound via the system, also connect the SCART (EURO AV) cable*.

La calidad de imagen mejorará en comparación con la que se obtiene mediante el Método 1. Para escuchar el sonido estéreo del televisor a través del sistema, también debe conectar un cable SCART (EURO AV)*.

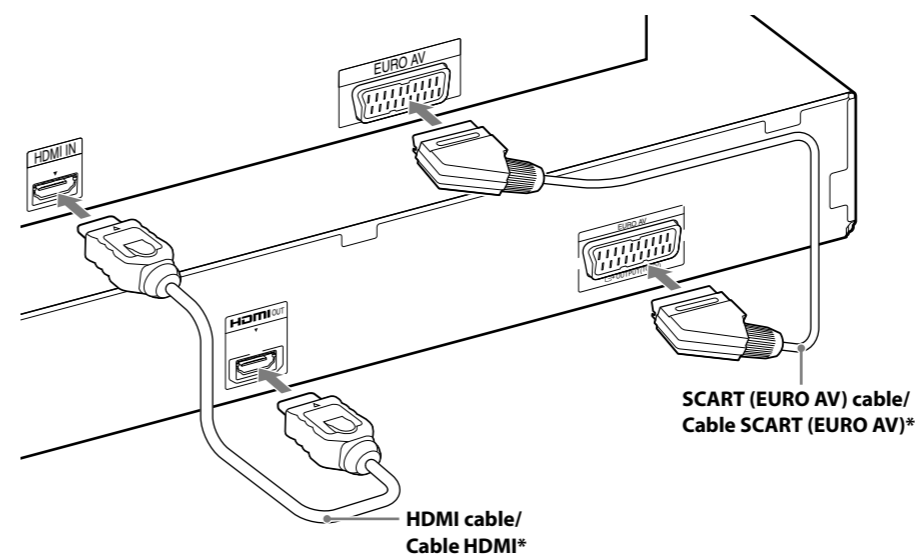

*Not supplied/No suministrado

3 Performing the Quick Setup/Realización del ajuste rápido

Note

Do not insert a disc before performing the Quick Setup.

Nota

No inserte ningún disco antes de realizar el ajuste rápido.

1 Connect the AC power cord.

The shape of the wall outlet differs depending on the area.

Conecte el cable de alimentación de ca.

La forma de la toma de pared varía en función de la zona.

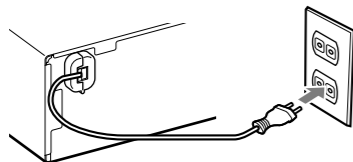

2 Turn on the power of the main unit and TV.

Encienda la unidad principal y el televisor.

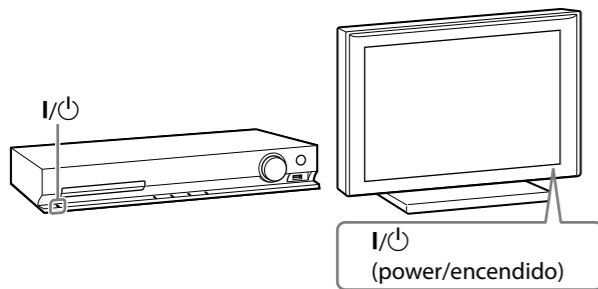

3 Switch the input selector on your TV to display "SONY Home Theatre System."

Cambie el ajuste del selector de entrada del televisor para visualizar "SONY Home Theatre System".

4 Set each following item, using ←/↑/↓/→ and +.

Displayed items vary depending on the area.

Ajuste cada uno de los elementos siguientes mediante ←/↑/↓/→ y +.

Los elementos que aparecen varían en función de la zona.

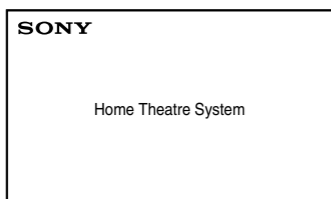
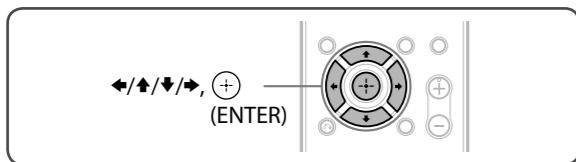

Select an on-screen language.

Seleccione un idioma para las indicaciones en pantalla.

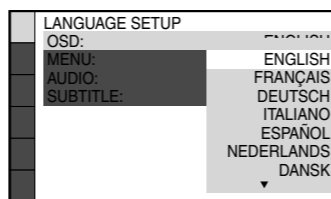

Select the aspect ratio of the connected TV.

Seleccione el formato del televisor conectado.

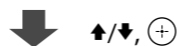
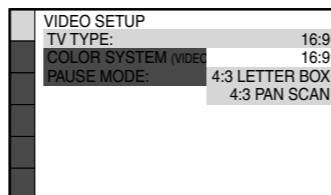

Select the output method for video signals.

Seleccione el método de salida de las señales de vídeo.

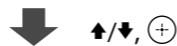
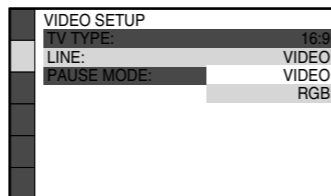

Select [ON] when you connect the main unit and the TV with an HDMI cable.

Seleccione [SI] si conecta la unidad principal y el televisor con un cable HDMI.

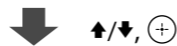
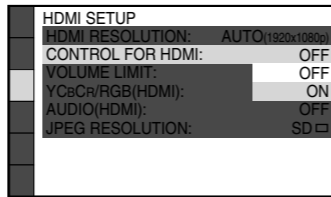

Select the speaker formation.

Seleccione la disposición de los altavoces.

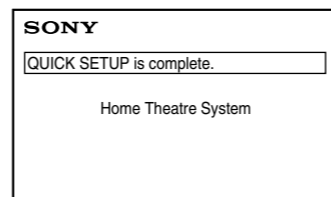
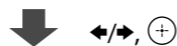
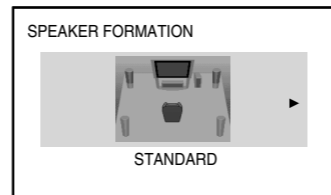

Listening to TV sound from all speakers/Audición del sonido del televisor a través de todos los altavoces

1 Press TV. Pulse TV.

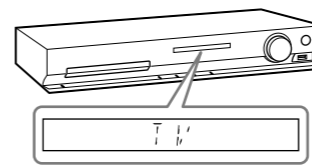
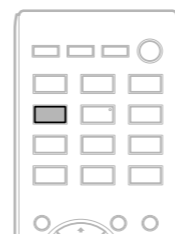

2 Press SYSTEM MENU. Pulse SYSTEM MENU.

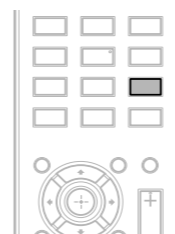

3 Press ↑/↓ to display "SUR.SETTING," then press +.

Pulse ↑/↓ hasta que aparezca "SUR.SETTING" y, a continuación, pulse +.

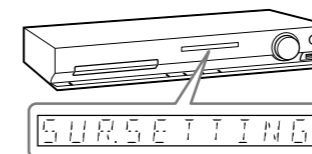
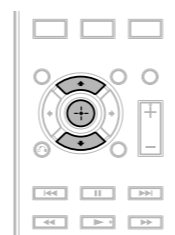

4 Press ↑/↓ to display "PRO LOGIC," then press +.

Pulse ↑/↓ hasta que aparezca "PRO LOGIC" y, a continuación, pulse +.

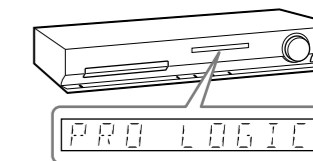
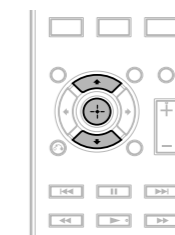

5 Press SYSTEM MENU to exit the menu.

Pulse SYSTEM MENU para salir del menú.

